

ORDINANCE NUMBER 743

AN ORDINANCE OF THE CITY OF KETCHUM, IDAHO, TO BE KNOWN AS THE "DARK SKY ORDINANCE" ESTABLISHING REGULATIONS AND GUIDELINES FOR EXTERIOR LIGHTING; PROVIDING FOR GENERAL PROVISIONS, DEFINITIONS, CRITERIA, NOTIFICATION, THE CITY'S ROLE, AND VIOLATIONS, LEGAL ACTIONS AND PENALTIES; PROVIDING A SAVINGS AND SEVERABILITY CLAUSE; PROVIDING A REPEALER CLAUSE; AND, PROVIDING AN EFFECTIVE DATE.

WHEREAS, unnecessary and improperly designed light fixtures cause glare, light pollution and wasted resources; and,

WHEREAS, glare and light pollution can result in: hazardous circulation conditions for all modes of transportation; the diminishing ability to view the night sky; light trespass; and, unattractive townscape; and,

WHEREAS, the people who live in and near Ketchum value the natural environment, including the beauty and high quality of the night sky; and,

WHEREAS, the City of Ketchum is a destination resort community, economically dependent upon tourists and part-time residents, and is dependent upon its natural resources and environment to attract tourists and part-time residents; and,

WHEREAS, the City of Ketchum desires to protect the health, safety and welfare of the (residents, tourists, motorists and) general public, and to protect the night sky that adds to the quality of life and economic well being of the City; and,

WHEREAS, these regulations for exterior lighting will not sacrifice the safety of our citizens or visitors, or the security of property, but instead will result in safer, efficient and more cost-effective lighting.

NOW, THEREFORE, BE IT ORDAINED BY THE MAYOR AND CITY COUNCIL OF THE CITY OF KETCHUM, IDAHO:

SECTION 1 - GENERAL PROVISIONS

1.1 Title - This Ordinance together with the amendments thereto, shall be known and may be cited as the Ketchum Dark Sky Ordinance.

1.2 Purposes - The general purpose of this Ordinance is to protect and promote the public health, safety and welfare, the quality of life, and the ability to view the night sky, by establishing regulations and a process of review for exterior lighting. This Ordinance establishes standards for exterior lighting in order to accomplish the following:

- a. To protect against direct glare and excessive lighting;
- b. To provide safe roadways for motorists, cyclists and pedestrians;
- c. To protect and reclaim the ability to view the night sky, and thereby help preserve the quality of life and the tourist experience;

- d. To prevent light trespass in all areas of the City;
- e. To promote efficient and cost effective lighting;
- f. To ensure that sufficient lighting can be provided where needed to promote safety and security;
- g. To allow for flexibility in the style of lighting fixtures;
- h. To provide lighting guidelines;
- i. To provide assistance to property owners and occupants in bringing nonconforming lighting into conformance with this Ordinance; and,
- j. To work with other jurisdictions within Blaine County to meet the purposes of this Ordinance.

1.3 Scope - All exterior lighting installed after the effective date of this Ordinance in any and all zoning districts in the City of Ketchum shall be in conformance with the requirements established by this Ordinance and any other applicable ordinances. All existing lighting installed prior to the effective date of this Ordinance in any and all zoning districts in the City of Ketchum shall be addressed as follows:

- a. All existing lighting located on a subject property that is part of an application for a City of Ketchum Planning Department Design Review, Conditional Use, or Subdivision Permit, or Building Permit is required to be brought into conformance with this Ordinance. Conformity shall occur prior to issuance of Certificate of Occupancy, Final Inspection, or Final Plat Recordation, when applicable. For other permits, the applicant shall have a maximum of thirty (30) days from date of permit issuance to bring the lighting into conformance.
- b. All existing exterior commercial lighting that is not in conformance with this Ordinance shall be brought into conformance with this Ordinance within twelve (12) months from the date of adoption of this Ordinance, by June 30, 2000.
- c. All existing lighting that does not meet the requirement of Zoning Ordinance Number 208, Section XXIV, Subsection 24.5, which states that "any parking, yard, or building illumination in [any] zoning [district] shall be so directed as to protect adjacent properties from glare and direct lighting" is required to be brought into conformance with this Section of Zoning Ordinance Number 208.
- d. All existing exterior residential lighting, not affected by (a) and (c) above, that does not comply with this Ordinance is required to be brought into conformance with this Ordinance within two years from the date of adoption of this Ordinance, by June 30, 2001.
- e. In the event of a discrepancy in applicable ordinances, the most restrictive shall apply.

SECTION 2 - DEFINITIONS

Unless specifically defined below, words or phrases used in this Ordinance shall be interpreted so as to give them the meaning they have in common usage and to give this Section its most reasonable application.

2.1 Area Light - Light that produces over 1800 lumens (See Addendum 1 for Light Output of Various Lamps). Area lights include, but are not limited to, street lights, parking lot lights and yard lights.

2.2 Average Footcandle - The level of light measured at an average point of illumination between the brightest and darkest areas. The measurement can be made at the ground surface or at four to five feet above the ground.

2.3 Ballast - A device used with a discharge lamp to obtain the necessary voltage, current, and/or wave form for starting and operating the lamp.

2.4 Building Official - The City of Ketchum Building Official.

2.5 Bulb - The source of electric light. To be distinguished from the whole assembly (See Luminaire).

2.6 Candela (cd) - Unit of luminous intensity.

2.7 Commission - The City of Ketchum Planning and Zoning Commission.

2.8 Eighty-five (85) Degree Full Cut-Off Type Fixtures - Fixtures that do not allow light to escape above an 85 degree angle measured from a vertical line from the center of the lamp extended to the ground. (See Figure 2).

2.9 Existing Lighting - Any and all lighting installed prior to the effective date of this Ordinance.

2.10 Exterior Lighting - Temporary or permanent lighting that is installed, located or used in such a manner to cause light rays to shine outside. Fixtures that are installed indoors that are intended to light something outside are considered exterior lighting for the intent of this Ordinance.

2.11 Fixture - The assembly that holds the lamp in a lighting system. It includes the elements designed to give light output control, such as a reflector (mirror) or refractor (lens), the ballast, housing, and the attachment parts.

2.12 Flood Light - Light that produces up to 1800 lumens (See Addendum 1 for Light Output of Various Lamps) and is designed to "flood" a well-defined area with light. Generally, flood lights produce from 1000 to 1800 lumens.

2.13 Flux (radiant flux) - Unit is erg/sec or watts.

2.14 Footcandle - Illuminance produced on a surface one foot from a uniform point source of one candela. Measured by a light meter.

2.15 Full Cut-Off Fixtures - Fixtures, as installed, that are designed or shielded in such a manner that all light rays emitted by the fixture, either directly from the lamps or indirectly

from the fixture, are projected below a horizontal plane running through the lowest point on the fixture where light is emitted. (See Figure 1).

2.16 Glare - Intense light that results in discomfort and/or a reduction of visual performance and visibility.

2.17 Holiday Lighting - Festoon type lights, limited to small individual bulbs on a string, where the spacing of bulbs is not closer than three inches and where the output per bulb is no greater than 15 lumens.

2.18 IESNA - Illuminating Engineering Society of North America (IES or IESNA) - The professional society of lighting engineers, including those from manufacturing companies, and others professionally involved in lighting.

2.19 Illuminance - Density of luminous flux incident on a surface. Unit is footcandle or lux.

2.20 Lamp - The source of electric light: the bulb and its housing. To be distinguished from the whole assembly (See Luminaire).

2.21 Light - The form of radiant energy acting on the retina of the eye to make sight possible; brightness; illumination; a lamp, as defined above.

2.22 Light Pollution - Any adverse effect of manmade light including, but not limited to, light trespass, uplighting, the uncomfortable distraction to the eye, or any manmade light that diminishes the ability to view the night sky. Often used to denote urban sky glow.

2.23 Light Trespass - Light falling where it is not wanted or needed, generally caused by a light on a property that shines onto the property of others.

2.24 Lighting - Any or all parts of a luminaire that function to produce light.

2.25 Lumen - Unit of luminous flux; the flux emitted within a unit solid angle by a point source with a uniform luminous intensity of one candela. One footcandle is one lumen per square foot. One lux is one lumen per square meter.

2.26 Luminaire - The complete lighting unit, including the lamp, the fixture, and other parts.

2.27 Luminance - At a point and in a given direction, the luminous intensity in the given direction produced by an element of the surface surrounding the point divided by the area of the projection of the element on a plane perpendicular to the given direction. Units: candelas per unit area. The luminance is the perceived brightness that we see, the visual effect of the illuminance, reflected, emitted or transmitted from a surface.

2.28 Non-Essential - Lighting that is not necessary for an intended purpose after the purpose has been served. Does not include any lighting used for safety and/or public circulation purposes. Example: For purposes of this Ordinance, lighting for a business sign is considered

essential during business hours, however, is considered non-essential once the business is closed.

2.29 Partially Shielded - The bulb of the fixture is shielded by a translucent siding and the bulb is not visible at all. Light may be emitted at the horizontal level of the bulb. (See Figure 3).

2.30 Planning and Zoning Administrator - The City of Ketchum Planning and Zoning Administrator or a member of the City of Ketchum Planning Department Staff.

2.31 Recessed - When a light is built into a structure or portion of a structure such that the light is fully cut-off and no part of the light extends or protrudes beyond the underside of a structure or portion of a structure.

2.32 Shielded - When the light emitted from the fixture is projected below a horizontal plane running through the lowest point of the fixture where light is emitted. The bulb is not visible with a shielded light fixture, and no light is emitted from the sides of the fixture. Also considered a full cut-off fixture. (See Figure 4).

2.33 Temporary Lighting - Means lighting that is intended to be used for a special event for seven (7) days or less.

2.34 Uplighting - Lighting that is directed in such a manner as to shine light rays above the horizontal plane.

SECTION 3 - CRITERIA

The Commission, the Building Official and/or the Planning and Zoning Administrator shall have the authority to require new lighting, and existing lighting pursuant to Section 1.3(a) hereinabove, to meet the recommendations and guidelines, in addition to the requirements of this Ordinance.

3.1 All applications for Design Review, Conditional Use, Subdivision and/or Building Permits shall include lighting plans showing location, type, height, and lumen output of all proposed and existing fixtures. The applicant shall provide enough information to verify that lighting conforms to the provisions of this Ordinance. The Planning and Zoning Administrator, Commission and/or Building Official shall have the authority to request additional information in order to achieve the purposes of this Ordinance.

3.2 All exterior lighting shall be full cut-off fixtures with the light source fully shielded, with the following exceptions:

- a. Luminaires that have a maximum output of 260 lumens per fixture, regardless of number of bulbs, (equal to one 20 watt incandescent light), may be left unshielded provided the fixture has an opaque top to keep light from shining directly up. (See Figure 5).

- b. Luminaires that have a maximum output of 1,000 lumens per fixture, regardless of number of bulbs, (equal to one 60 watt incandescent light) may be partially shielded, provided the bulb is not visible, and the fixture has an opaque top to keep light from shining directly up. (See Figure 3).
- c. Flood lights with external shielding may be angled provided that no light escapes above a 25 degree angle measured from the vertical line from the center of the light extended to the ground, and only if the light does not cause glare or light to shine on adjacent property or public rights-of-way. (See Figure 6). Flood lights with directional shielding are encouraged. (See Figure 7). Photocells with timers that allow a floodlight to go on at dusk and off by 11:00 p.m. are encouraged.
- d. Holiday lights as defined in Subsection 2.17 are exempt from the requirements of this Ordinance for the six and one half month period from November 1 to April 15, except that flashing holiday lights are prohibited on commercial properties. Flashing holiday lights on residential properties are discouraged. Holiday lights are encouraged to be turned off after bedtime and after close of businesses.
- e. Sensor activated lighting may be unshielded provided it is located in such a manner as to prevent direct glare and lighting into properties of others or into a public right-of-way, and provided the light is set to only go on when activated and to go off within five minutes after activation has ceased, and the light shall not be triggered by activity off the property.
- f. Vehicular lights and all temporary emergency lighting needed by the Fire and Police Departments, or other emergency services shall be exempt from the requirements of this Ordinance.

3.3 Light Trespass - It is the intent of this Ordinance to eliminate and prevent light trespass through the proper installation of lighting fixtures. All existing and/or new exterior lighting shall not cause light trespass and shall be such as to protect adjacent properties from glare and excessive lighting.

3.4 IESNA Guidelines - The Commission may require that any new lighting or existing lighting that comes before them meet the standards for footcandle output as established by IESNA.

3.5 All non-essential exterior commercial and residential lighting is encouraged to be turned off after business hours and/or when not in use. Lights on a timer are encouraged. Sensor activated lights are encouraged to replace existing lighting that is desired for security purposes.

3.6 Area Lights - All area lights, including street lights and parking area lighting, shall be full cut-off fixtures and are encouraged to be eighty-five (85) degree full cut-off type fixtures. Street lights shall be in accordance with the Idaho Power Franchise Agreement and/or the Light Conformance Schedule adopted by resolution by the City Council. Street lights shall be high pressure sodium, low pressure sodium, or metal halide, unless otherwise determined by the Council that another type is more efficient. Street lights along residential streets shall be limited to a 70 watt high pressure sodium (hps) light. Street lights along nonresidential streets or at intersections shall be limited to 100 watts hps, except that lights at major intersections on state highways shall be limited to 200 watts hps. If the Council permits a light type other than high

pressure sodium, then the equivalent output shall be the limit for the other light type (See Addendum 1). For example: a 100 watt high pressure sodium lamp has a roughly equivalent output as a 55 watt low pressure sodium lamp, or a 100 watt metal halide lamp.

Parking area lights are encouraged to be greater in number, lower in height and lower in light level, as opposed to fewer in number, higher in height and higher in light level. Parking lot lighting shall not exceed IESNA recommended footcandle levels.

All freestanding area lights within a residential zone, except street lights, shall be mounted at a height equal to or less than the value $3 + (D/3)$, where D is the distance in feet to the nearest property boundary.

3.7 Luminaire Mounting Height - Free standing luminaires shall be no higher than 25 feet above the stand/pole base, except that luminaires used for playing fields shall be exempt from the height restriction provided all other provisions of this Ordinance are met and the light is used only while the field is in use, and except that street lights used on major roads may exceed this standard if necessary as determined by the City Council, as advised by a lighting engineer. Building mounted luminaires shall be attached only to walls, and the top of the fixture shall not exceed the height of the parapet or roof, whichever is greater.

3.8 Uplighting - Uplighting is prohibited in all zoning districts, except in cases where the fixture is shielded by a roof overhang or similar structural shield from the sky and a Idaho licensed architect or engineer has stamped a prepared lighting plan that ensures that the light fixture(s) will not cause light to extend beyond the structural shield, and except as specifically permitted in this Ordinance.

3.9 Flag Poles - Upward flagpole lighting is permitted for governmental flags only, and provided that the maximum lumen output is 1300 lumens. Flags are encouraged to be taken down at sunset to avoid the need for lighting.

3.10 Service Stations - The average footcandle lighting level for new and existing service stations is required to be no greater than 30 footcandles, as set by the IESNA for urban service stations.

3.11 Canopy Lights - All lighting shall be recessed sufficiently so as to ensure that no light source is visible from or causes glare on public rights-of-way or adjacent property.

3.12 Landscape Lighting - Lighting of vegetation is discouraged and shall be in conformance with this Ordinance. Uplighting is prohibited.

3.13 Towers - All radio, communication, and navigation towers that require lights shall have dual lighting capabilities. For daytime, the white strobe light may be used, and for nighttime, only red lights shall be used.

3.14 Temporary Lighting - Temporary lighting that conforms to the requirements of this Ordinance shall be allowed. Nonconforming temporary exterior lighting may be permitted by the Planning and Zoning Administrator only after considering 1) the public and/or private

benefits which will result from the temporary lighting; 2) any annoyance or safety problems that may result from the use of the temporary lighting; and, 3) the duration of the temporary nonconforming lighting. The applicant shall submit a detailed description of the proposed temporary nonconforming lighting to the Planning and Zoning Administrator. The Administrator shall provide written notice of said request to owners of property immediately adjacent to the subject property. Said notice shall inform adjacent property owners they may comment on the request during a period of not less than ten (10) days after mailing of the notice and prior to final action on said request.

3.15 Neon Lights - Neon lights are only permitted pursuant to the Sign Ordinance, Section XXIV, Zoning Ordinance Number 208.

3.16 The attached figures and information sheets shall be incorporated into this Ordinance as guidelines for the public and the City for use in meeting the intent of this Ordinance. The figures and information sheets only serve as examples. The City does not endorse or discriminate against any manufacturer or company that may be shown, portrayed or mentioned by the examples. Additional information is provided at the Ketchum Planning Department

SECTION 4 - NOTIFICATION

4.1 The City of Ketchum Building and Planning Department permits shall include a statement asking whether the subject property of the proposed work includes any exterior lighting.

4.2 Within thirty (30) days of the enactment of this Ordinance, the Planning and Zoning Administrator shall send a copy of the Dark Sky Ordinance with a cover letter to all local electricians and local electric suppliers listed in the local 1999 telephone books, as well as to the Ketchum/Sun Valley Chamber of Commerce. Within ninety (90) days (coincide with next available mailing) the Planning and Zoning Administrator shall send notice to all property owners on the Ketchum Water/Sewer mailing list.

SECTION 5 - THE CITY'S ROLE

5.1 The City of Ketchum will commit to changing all lighting within the City rights-of-way and on City-owned property to meet the requirements of this Ordinance through the franchise agreement with the power company and/or through the Light Conformance Schedule adopted by resolution by the Council.

5.2 The City of Ketchum will assist property owners and/or occupants to correct any nonconforming lighting through consulting with the owner/occupant and assisting in the provision of shields.

SECTION 6 - VIOLATIONS, LEGAL ACTIONS AND PENALTIES

6.1 Violations and Legal Actions - If, after investigation, the Planning and Zoning Administrator finds that any provision of this Ordinance is being violated, the Administrator shall give notice by hand delivery or by certified mail, return receipt requested, of such

violation to the owner and/or to the occupant of such premises, demanding that the violation be abated within thirty (30) days of the date of hand delivery or of the date of mailing of the notice. The Planning Department Staff shall be available to assist in working with the violator to correct said violation. If the violation is not abated within the thirty (30) day period, the Administrator may institute actions and proceedings, either legal or equitable, to enjoin, restrain or abate any violations of this Ordinance and to collect the penalties for such violations.

6.2 Penalty - A violation of this Ordinance, or any provision thereof, shall be punishable by a civil penalty of one hundred dollars (\$100) and each day of violation after the expiration of the thirty (30) day period provided in Subsection 6.1 above, shall constitute a separate offense for the purpose of calculating the civil penalty.

SECTION 7 - SAVINGS AND SEVERABILITY CLAUSE

It is hereby declared to be the legislative intent that the provisions and parts of this Ordinance shall be severable. If any paragraph, part, section, subsection, sentence, clause or phrase of this Ordinance is for any reason held to be invalid for any reason by a court of competent jurisdiction, such decision shall not affect the validity of the remaining portions of this Ordinance.

SECTION 8 - REPEALER CLAUSE

All City of Ketchum ordinances or resolutions or parts thereof which are in conflict herewith are hereby repealed.

SECTION 9 - EFFECTIVE DATE

This Ordinance shall be in full force and effect from and after its passage, approval and publication.

PASSED BY THE CITY COUNCIL OF THE CITY OF KETCHUM, IDAHO and approved by the Mayor this 21st day of June, 1999.

Guy P. Coles
Mayor

Attest:

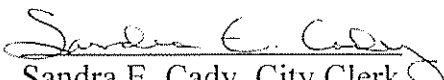
Sandra E. Cady, City Clerk

Publish: Idaho Mountain Express
June 30, 1999

Figure 8

NEMA Head Fixtures



Without Shield



With Shield

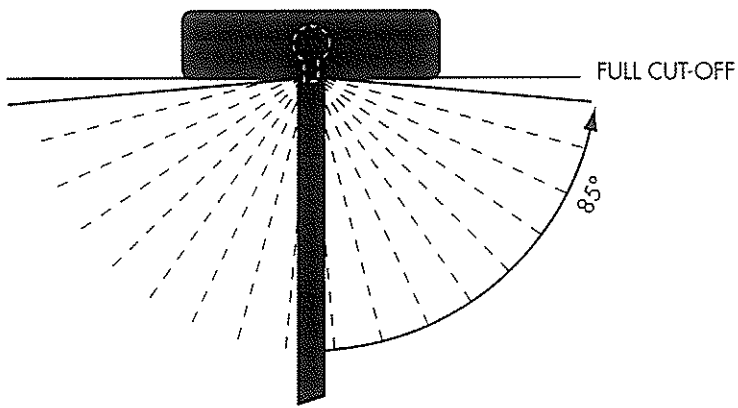

FIGURE 2

85° Full Cut-Off Fixture

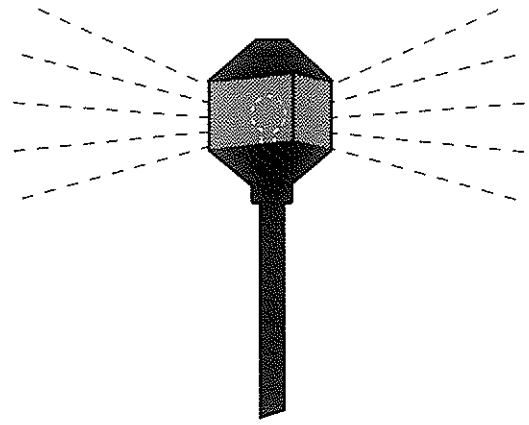

FIGURE 3

Partially Shielded
(translucent siding - bulb not visible)

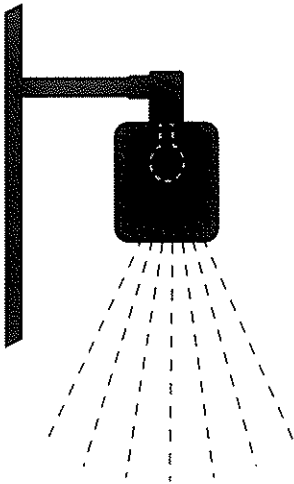

FIGURE 4

Shielded

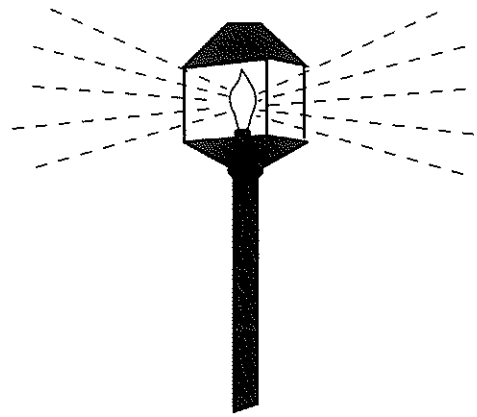

FIGURE 5

Unshielded with Opaque Top
(less than 260 lumens)

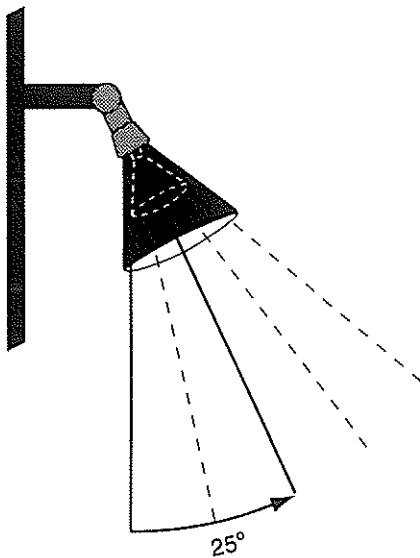

FIGURE 6

Angle of Flood Light
with External Shielding

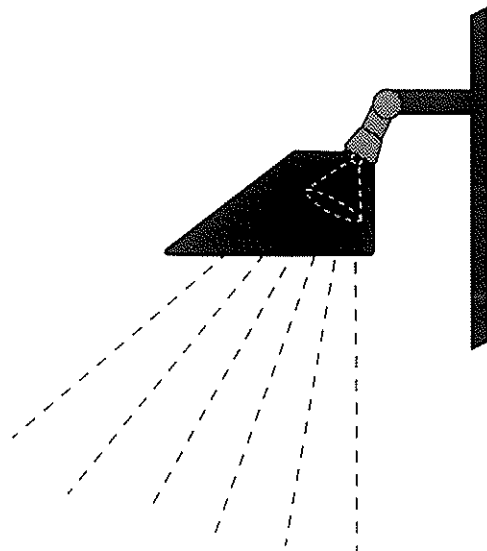
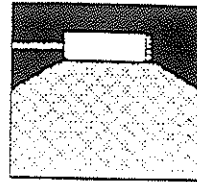

FIGURE 7

Directional Flood Light

Figure 1

What is a True "Full Cutoff" Outdoor Lighting Fixture?



Information Sheet I-43, October 1998



International Dark-Sky Association
3225 N. First Ave., Tucson, AZ 85719 U.S.A.
E-mail: ida@darksky.org
WWW: <http://www.darksky.org>

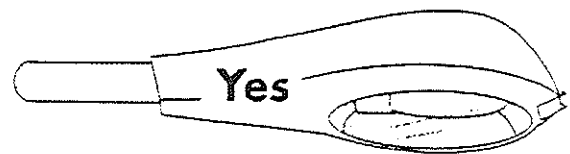
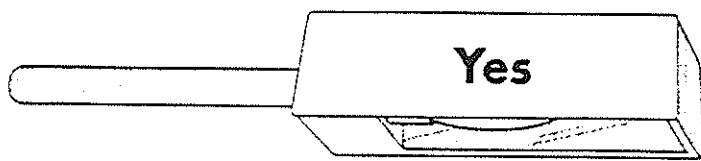

Flat glass lens, eliminates or minimizes direct glare, no upward throw of light. The housing for these fixtures is available in many styles.

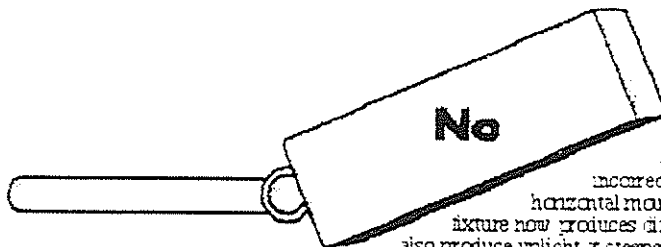
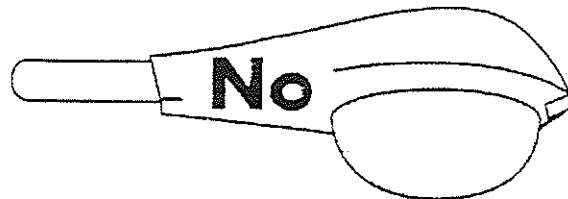
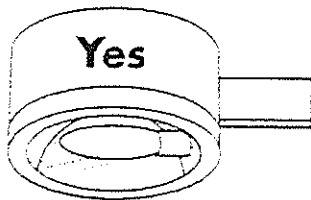

Same fixture as above mounted incorrectly—defeating the horizontal mounting design. The fixture now produces direct glare and can also produce uplight or steeper mounting angles.

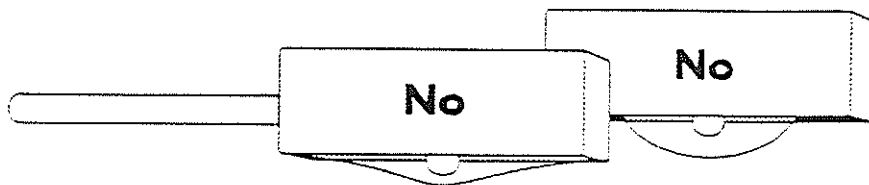

Known as just "Cutoff". Center "drop" or "sag" lens with or without exposed bulb, produces direct glare.

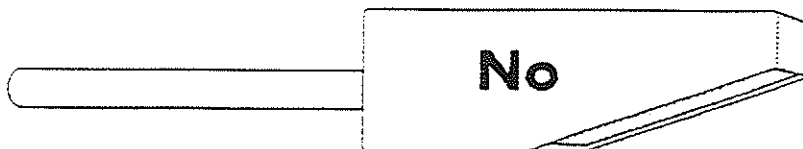

Forward-Throw Style. Exposed bulb in the forward direction produces some direct glare.

Addendum 1

INITIAL RATED LIGHT OUTPUT OF VARIOUS LAMPS

(Information from Sylvania #PL-150, General Electric #9200 and Philips #SG-100 large lamp catalogs)

LAMP TYPE	LAMP WATTAGE	INITIAL LUMEN OUTPUT
INCANDESCENT LAMP (FROSTED) (Syl.)	25	235
INCANDESCENT LAMP (FROSTED) (Syl.)	40	375
INCANDESCENT LAMP (FROSTED) (Syl.)	60	890
INCANDESCENT LAMP (FROSTED) (Syl.)	100	1690
INCANDESCENT LAMP (FROSTED) (Syl.)	150	2850
INCANDESCENT FLOOD OR SPOT (G.E.)	75	765
INCANDESCENT FLOOD OR SPOT (G.E.)	120	1500
INCANDESCENT FLOOD OR SPOT (G.E.)	150	2000
QUARTZ-HALOGEN LAMP (FROSTED) (Syl.)	42	665
QUARTZ-HALOGEN LAMP (FROSTED) (Syl.)	52	885
QUARTZ-HALOGEN LAMP (FROSTED) (Syl.)	72	1300
QUARTZ-HALOGEN LAMP (FROSTED) (Syl.)	300	6000
QUARTZ-HALOGEN LAMP (FROSTED) (Syl.)	500	10500
QUARTZ-HALOGEN LAMP (FROSTED) (Syl.)	1000	21000
QUARTZ-HALOGEN MINI FLOOD OR SPOT (G.E.) (12 volt MR-16 type)	20	250
QUARTZ-HALOGEN MINI FLOOD OR SPOT (G.E.) (12 volt MR-16 type)	42	630
QUARTZ-HALOGEN MINI FLOOD OR SPOT (G.E.) (12 volt MR-16 type)	50	895
QUARTZ-HALOGEN MINI FLOOD OR SPOT (G.E.) (12 volt MR-16 type)	75	1300
FLUORESCENT LAMP (Philips)	7	400
FLUORESCENT LAMP (Philips)	9	600
FLUORESCENT LAMP (Philips)	13	900
FLUORESCENT LAMP (Philips)	22	1200
FLUORESCENT LAMP (Philips)	28	1600
FLUORESCENT LAMP (G.E. cool white)	40	3150
LOW PRESSURE SODIUM LAMP (Philips)	18	1800
LOW PRESSURE SODIUM LAMP (Philips)	35	4800
LOW PRESSURE SODIUM LAMP (Philips)	55	8000
LOW PRESSURE SODIUM LAMP (Philips)	90	13500
LOW PRESSURE SODIUM LAMP (Philips)	135	22500
LOW PRESSURE SODIUM LAMP (Philips)	180	33000
HIGH PRESSURE SODIUM LAMP (DIFFUSE) (G.E.)	35	2250
HIGH PRESSURE SODIUM LAMP (DIFFUSE) (G.E.)	50	4000
HIGH PRESSURE SODIUM LAMP (DIFFUSE) (G.E.)	70	6400
HIGH PRESSURE SODIUM LAMP (DIFFUSE) (G.E.)	100	9500
HIGH PRESSURE SODIUM LAMP (DIFFUSE) (G.E.)	150	16000
HIGH PRESSURE SODIUM LAMP (DIFFUSE) (G.E.)	250	27500
HIGH PRESSURE SODIUM LAMP (DIFFUSE) (G.E.)	400	50000
MERCURY VAPOR LAMP (WHITE DELUXE) (Syl.)	100	4500
MERCURY VAPOR LAMP (WHITE DELUXE) (Syl.)	175	850
MERCURY VAPOR LAMP (WHITE DELUXE) (Syl.)	250	11100
MERCURY VAPOR LAMP (WHITE DELUXE) (Syl.)	400	20100
METAL HALIDE LAMP (Coated) (G.E.)	32	2500
METAL HALIDE LAMP (Coated) (Venture)	50	3400
METAL HALIDE LAMP (Coated) (G.E.)	100	9000
METAL HALIDE LAMP (Coated) (G.E.)	175	15750
METAL HALIDE LAMP (Coated) (G.E.)	250	20500
METAL HALIDE LAMP (Coated) (G.E.)	400	36000